

ROTEL *hi-fi*

RB-970BX STEREO POWER AMPLIFIER

OWNER'S MANUAL

WARNING:
TO PREVENT FIRE OR SHOCK HAZARD,
DO NOT EXPOSE THIS APPLIANCE TO
RAIN OR MOISTURE.

Write your SERIAL NUMBER here.
The number is located near the
identification plate on the rear panel.



SAFETY INSTRUCTIONS

Please read this section carefully before you begin, in order to ensure the best safe-guarding both of yourself and that of your equipment at all times:

1. **Read Instructions** - All the safety and operating instructions should be read before the appliance is operated.
2. **Retain Instructions** - The safety and operating instructions should be retained for future reference.
3. **Heed Warnings** - All warnings on the appliance and in the operating instructions should be adhered to.
4. **Follow Instructions** - All operating and use instructions should be followed.
5. **Water and Moisture** - The appliance should not be used near water - for example, near a bathtub, washbowl, kitchen sink, laundry tub, in a wet basement or near a swimming pool, etc.
6. **Carts and Stands** - The appliance should be used only with a cart or stand that is recommended by the manufacturer.
- 6A. An appliance and cart combination should be moved with care. Quick stops, excessive force and uneven surfaces may cause the appliance and cart combination to overturn.
7. **Wall or Ceiling Mounting** - The appliance should be mounted to a wall or ceiling only as recommended by the manufacturer.
8. **Ventilation** - The appliance should be situated so that its location or position does not interfere with its proper ventilation. For example, the appliance should not be situated on a bed, sofa, rug, or similar surface that may block the ventilation openings; or placed in a built-in installation, such as a bookcase or cabinet that may that may impede the flow of air through the ventilation openings.
9. **Heat** - The appliance should be situated away from heat sources such as radiators, heat registers, stoves or other appliances (including amplifiers) that produce heat.
10. **Power Sources** - The appliance should be connected to a power supply only of the type described in the operating instructions or as marked on the appliance.
11. **Grounding or Polarization** - The precautions that should be taken so that the grounding or polarization means of an appliance is not defeated.
12. **Power-Cord Protection** - Power supply cords should be routed so that they are not likely to be walked on or pinched by items placed upon or against them, paying particular attention to cords and plugs, convenience receptacles and the point where they exit from the appliance.
13. **Cleaning** - The appliance should be cleaned only as recommended by the manufacturer.
14. **Power Lines** - An outdoor antenna should be located away from the power lines.
15. **Nonuse Periods** - The power cord of the appliance should be unplugged from the outlet when left unused for a long period of time.
16. **Object and Liquid Entry** - Care should be taken so that objects do not fall and liquids are not spilled into the enclosure through the openings. -
17. **Damage Requiring Service** - The appliance should be serviced by qualified factory-authorized service personnel when:
 - The power-supply cord or the plug has been damaged; or
 - Objects have fallen, or liquid has been spilled into the appliance; or
 - The appliance has been exposed to rain; or
 - The appliance does not appear to operate normally or exhibits a marked change in performance; or
 - The appliance has been dropped, or the enclosure damaged.
18. **Servicing** - The user should not attempt to service the appliance beyond that described in the operating instructions. All other servicing should be referred to qualified factory-authorized service personnel.



WARNING: To reduce the risk of fire or electric shock, do not expose this appliance to rain or moisture. Do not remove the panels. There are no user-serviceable parts inside. Refer servicing to qualified service personnel.

	CAUTION RISK OF ELECTRIC SHOCK DO NOT OPEN	
CAUTION: TO REDUCE THE RISK OF ELECTRIC SHOCK, DO NOT REMOVE COVER (OR BACK). NO USER-SERVICEABLE PARTS INSIDE. REFER SERVICING TO QUALIFIED SERVICE PERSONNEL.		

Explanation of Graphical Symbols

The lightning flash with arrowhead symbol, within an equilateral triangle, is intended to alert the user to the presence of uninsulated 'dangerous voltage' within the product's enclosure that may be of sufficient magnitude to constitute a risk of electric shock to persons.

The exclamation point within an equilateral triangle is intended to alert the user to the presence of important operating and maintenance instructions in the literature accompanying the appliance.



INTRODUCTION

A WORD FROM ROTEL

Rotel wishes to take this opportunity to thank you for choosing our product. Our commitment and dedication to the design and manufacturing of high fidelity products for more than thirty years have guided the creation of equipment with the highest level in sound reproduction. We are confident that you will enjoy your Rotel equipment, now and for many years to come.

Please read this instruction manual carefully before you start using your amplifier and keep it in a safe place for future reference. Thank you.

UNPACKING AND INSTALLING

UNPACKING & LOCATION

- Carefully unpack your power amplifier and place it gently at its intended location. Please keep the packaging material for future use in case you move or need to return the unit for service.
- Place the amplifier on a flat, firm surface where it will be free from direct sunlight, excessive humidity, vibrations, dust, heat or cold.
- Do not place audio or video cassettes on top of the amplifier because their content may be erased due to the magnetic fields created by the transformer located in the amplifier.
- Ensure the amplifier has sufficient ventilation. Do not block the ventilation openings at the top and bottom of the unit, to avoid damage from overheating.

ELECTRICAL REQUIREMENTS

Your equipment has been designed to be powered by your local AC (mains) supply. Before connecting it to the AC outlet, check the rating of your unit on the identification plate found on the rear panel. Never plug the unit into an outlet of voltage different to that specified. The wrong voltage can cause a serious fire hazard. Consult your dealer if in doubt.

EXCLUSIVE NOTE FOR U.K. - If your unit comes with a 2-core mains lead without a plug, neither core is to be connected to the earth terminal of a three pin plug, make certain they are connected according to the following instruction, to the proper terminals. Check that the terminals are screwed down firmly and no loose strands of wire are present. **IMPORTANT:** The wires in the mains lead are coloured in accordance with the following code:

BLUE = NEUTRAL / BROWN = LIVE

As the colours of the wires in the mains lead of this apparatus may not correspond with coloured markings identifying the terminals in your plug, proceed as follows: The wire which is coloured BLUE must be connected to the terminal which is marked with the letter N or coloured BLUE or BLACK. The wire which is coloured BROWN must be connected to the terminal which is marked with the letter L or coloured BROWN or RED.

DO NOT OPEN THE CABINET

There are no user-serviceable parts inside the unit. Do not attempt to open the cabinet, as this could damage your unit and void your warranty. If the amplifier is dropped, damaged or does not seem to function properly, disconnect the power cord immediately and consult your dealer.

CLEANING YOUR UNIT

If your unit becomes dirty, wipe it gently with a soft, clean, dry cloth. Never use solvents of any kind.

HUM AND NOISE

In any high fidelity installation, hum may be caused by the interconnection of a CD player, tapedeck, tuner, amplifier and speakers, as a result of wiring, different grounding or locations of the components. If hum or noise is experienced with your unit try one or a combination of the following measures:

- Check that all cable connections have been well and securely made, and that they do not run too close to a strong AC field.
- Use an improved outdoor antenna on your tuner, or move the equipment away from objects such as fluorescent lamps, rheostats and house appliances that use motors or thermostats, when receiving broadcasts.

- Connect a wire from the ground terminal on the rear panel of this unit, to the ground terminal on the applicable source unit (or any other point on the cabinet where noise can be brought down to a minimum). However, absolutely ensure the wire does not touch any areas related to the power source such as auxiliary AC outlets, and do not insert the wire inside the cabinet.
- Contact your dealer for further advice.

STEREO AND MONO OPERATION

The power amplifier can be used either as a normal stereo or as a bridged mono amplifier. The unit comes factory-set as a stereo amplifier (the BRIDGED switch on the back of the unit is set at the STEREO position). Do not tamper with the switch, unless you wish to use the unit as a mono amplifier, in which case reset the switch to the MONO position. Do not connect the speakers before the switch position is set correctly according to your choice. Two bridged mono amplifiers must be used for stereo operation.

MAKING THE CONNECTIONS

See Illustration 1 - Rear Panel, to visualize where the connections to components are to be made.

1. CONNECTING THE SPEAKERS:

- The illustration shows what audio components you can connect to the rear panel of the unit and how they should be properly hooked up via RCA type pin cords. Ensure that the Left and Right channels are correctly matched between the RCA type sockets of the unit and those on the components.
- Use speakers of impedance ratings of 4 to 16 ohms. However if you wish to operate the unit in bridged mode as a mono power amplifier with only one speaker, ensure the speaker is rated 8 ohms minimum. The speaker impedance will be indicated on the back of the speakers or in the speaker's instruction manual.
- Use proper speaker cords - which your dealer will normally recommend - with as low capacitance content as possible. The speaker connections (five-way binding posts) provided on the back of the amplifier are suitable for banana plugs, as well as bare wire or spade lugs.
- If connecting the speaker cords directly with bare wire ends, we suggest you strip off about 1 cm of the insulation shield cover from the ends of the speaker cords. Twist any exposed strands tightly, and insert the ends fully and securely into the terminals on the rear panel.
- Check that the speaker cord ends (exposed tips) on the terminal posts, have no stray wires touching one another, as this can cause short circuits and may damage both the amplifier and the speakers.
- When using the unit as a STEREO power amplifier: make sure the BRIDGED switch is set correctly to the STEREO position. Connect the Left and Right channels correctly between the speaker and the unit, and ensure for each channel that the "+" and "-" terminals are also correctly matched.
- When using the unit as a MONO power amplifier (bridged mode): make sure the BRIDGED switch is set correctly to the MONO position. Connect only one speaker to the power amplifier: connect the "+" speaker lead wire to the LEFT "+" terminal post on the power amplifier and the "-" speaker lead wire to the RIGHT "+" terminal post. Do not operate the amplifier with a common ground speaker switching device. This will damage the amplifier (and void your warranty). Consult your dealer if in doubt.

2. CONNECTING THE PREAMPLIFIER

See Illustrations 2, 3 and 4 - when using the unit as a stereo power amplifier, a monaural amplifier or as a stereo amplifier for bi-amplification, respectively.

- The stereo mode uses one preamplifier and one power amplifier.
- The "bridged" monaural mode uses one preamplifier and two mono power amplifiers
- The bi-amping mode uses one preamplifier or control amplifier, which has two sets of outputs connected in parallel, and two stereo power amplifiers, one driving the tweeters and the other driving the woofers of the speakers, which have separate connectors for the tweeters and the woofers.
- Ensure that regardless of the mode you choose, that the correct connections are done.

3. CONNECTING THE POWER CORD

- Always handle the power cord with care and never pull the plug out of the wall socket by tugging the cord. Hold the plug to remove it from the wall.
- Ensure the VOLUME control is set to the minimum position before plugging in the power cord.
- Connect the power cord to the AC (mains) outlet.
- When plugging and unplugging make sure the power switch on the unit is turned off.

NOTES: Verify that all connections are properly and securely made and that the amplifier and components have been plugged in. Using higher quality interconnect cables will improve sound quality

ILLUSTRATION 1 - REAR PANEL

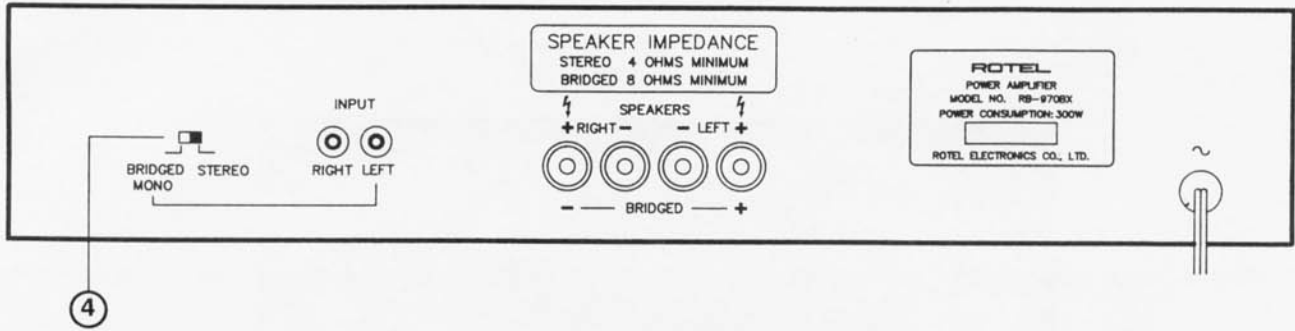

ILLUSTRATION 2 - WHEN USING THE UNIT AS A STEREO POWER AMPLIFIER

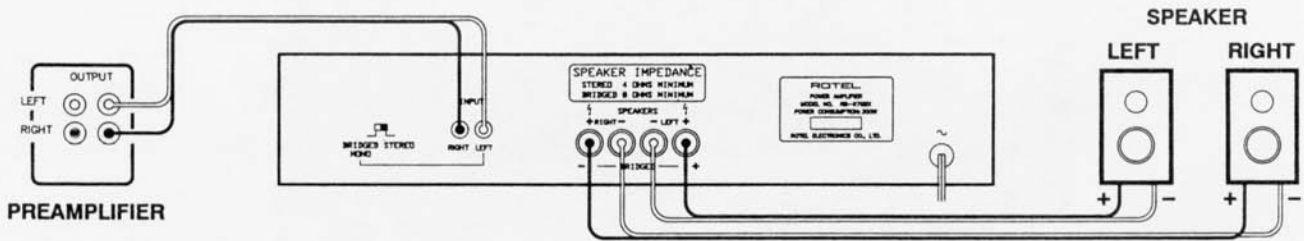

ILLUSTRATION 3 - WHEN USING THE UNIT AS A BRIDGED AMPLIFIER

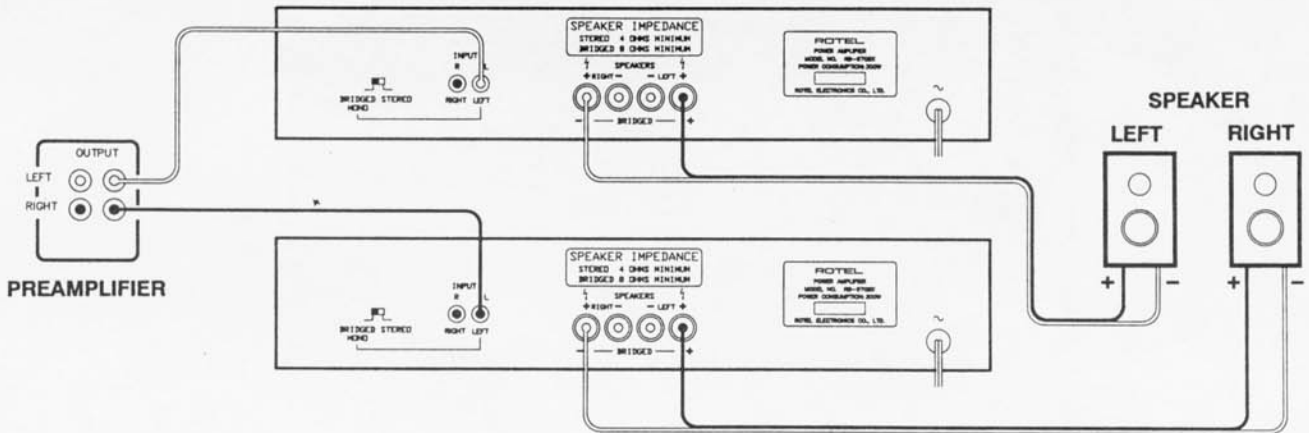
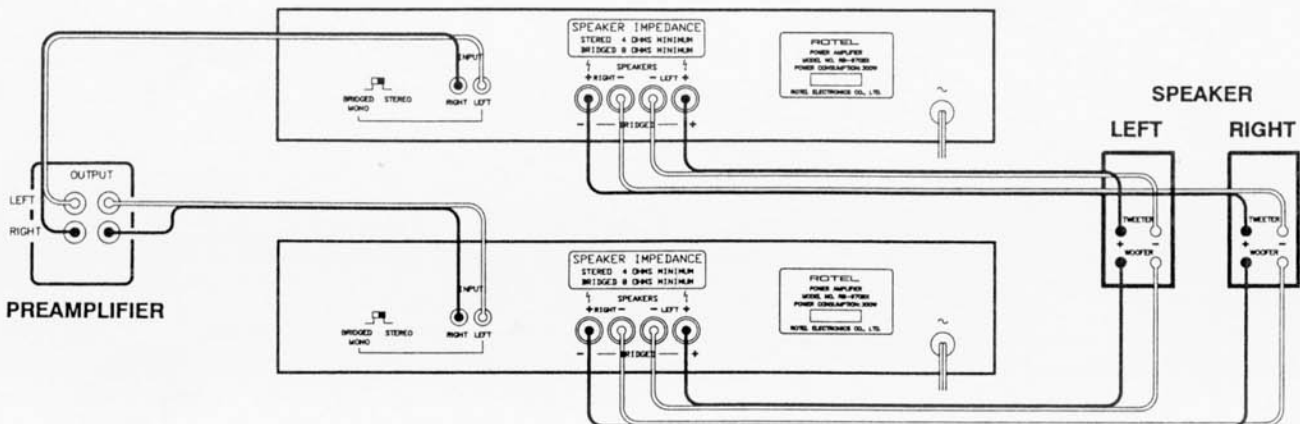

ILLUSTRATION 4 - WHEN USING THE UNIT AS A STEREO AMPLIFIER FOR BI-AMPLIFIER



LOCATION AND OPERATION OF CONTROLS AND INDICATORS

See Illustrations 1 and 5 - Rear and Front Panels, to visualize the location of the switches and controls.

NOTE: Ensure the volume control on the preamplifier is set to the minimum position before turning the power on.

1. POWER BUTTON

Switches the power on and off.

2. POWER INDICATOR

Glows when the power is turn on.

3. BRIDGED MONO INDICATOR

Lights up red to show that the BRIDGED switch on the rear panel is set to the MONO position.

4. BRIDGED SWITCH (REAR PANEL)

- When the BRIDGED switch is in the STEREO position, this is a stereo 2-channel power amplifier.
- When the BRIDGED switch is in the MONO position, this is a single channel monaural power amplifier.

ILLUSTRATION 5 – FRONT PANEL

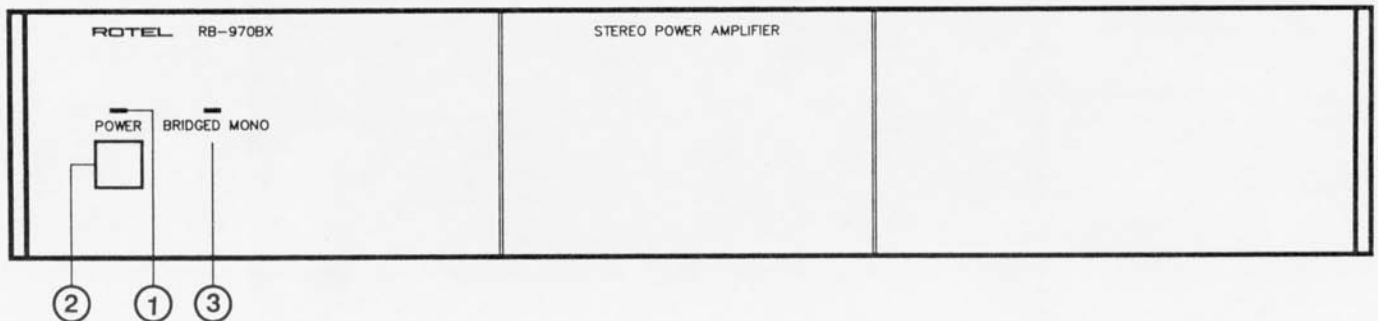

SPECIFICATIONS

Continuous Power Output	60 watts* per channel, min. RMS both channels driven into 8 ohms from 20 to 20,000 Hz with no more than 0.03% total harmonic distortion.
DIN Output	110 watts per channel (1kHz, 4 ohms, 1% THD)
Peak Current	30A (0.1 ohms, 10 μ sec, 1 pulse)
Power Output (BTL).....	180 watts (mono) min. RMS driven into 8 ohms from 20 to 20,000 Hz with no more than 0.03% total harmonic distortion.
Total Harmonic Distortion	No more than 0.03% (continuous rated power output)
(20 to 20,000 Hz)	No more than 0.03% (continuous 1/2 rated power output).
	No more than 0.05% (1 watt per channel power output, 8 ohms).
Intermodulation Distortion	No more than 0.05% (continuous rated power output)
(60 Hz : 7 kHz= 4:1)	No more than 0.05% (continuous 1/2 rated power output).
	No more than 0.05% (1 watt per channel power output, 8 ohms).
Output (Speakers)	8 ohms min (bridged mono mode); 4-16 ohms (stereo mode)
Damping Factor	280 (20 to 20,000 Hz, 8 ohms)
Input Sensitivity/Impedance	1.0 V / 27 kohms
Overload Level (THD 0.5 %, 1 kHz).....	5 V
Frequency Response	15 to 100,000 Hz, +0 dB, -1.0 dB
Signal to Noise Ratio (IHF, A network).....	116 dB

GENERAL

Power Requirement	120 V/60 Hz, 220-240 V/50 Hz (depending on destination)
Power Consumption	300 watts
Dimension (overall)	440 (W) x 92 (H) x 334 (D) mm
	17-3/8" x 3-5/8" x 13-3/16"
Weight (net).....	6.8 kg / 15.0 lbs

* Measured pursuant to the Federal Trade Commission's Trade Regulation Rule or, Power Claims for Amplifiers (applicable to the USA only).

NOTE: Specifications and design are subject to possible modification without notice.